

# BGDSFA FULL ACCESS DOCK SEAL

## FEATURES AND SPECIFICATIONS

Designed to accommodate 10' x 10' door openings, the BGDSFA is an ideal solution when full access to the trailer is required. Incoming trailers back safely through the vertical pads, forming a tight seal against the sides. The hook and loop split head curtain is raised and lowered to maintain an energy-efficient barrier without hindering access to the trailer interior.

Standard units seal trailers 12' to 13.5' high on a typical 4' dock height.

### STANDARD FEATURES:

- 16" projection
- 22 oz. Hi-Tear vinyl base fabric
- Hook and loop-split adjustable head curtain measuring 11.3" wide x 16" projection, plus 30" drop curtain
- High visibility 24" yellow guide stripe
- Waterproof wraparound design with vapor barrier
- Condensation draining vents
- 99% memory foam
- 6" wear flaps to absorb extra abrasion at high-wear areas\*
- Galvanized mounting hardware

For maximum value and performance, the BGDSFA can be constructed from our premium durability fabrics (see chart for materials, weights, and available colors).

### ADDITIONAL OPTIONS INCLUDE:

- PVC drop curtain
- 4", 8", or 16" wear flaps / pleats to suit site requirements



BGDSFA Full Access Dock Seal

### FABRIC AND COLOR SELECTION:

22oz Hi-Tear Vinyl	■	■	■	■
40oz Hi-Tear Vinyl	■	■	■	■
50oz Hi-Tear Vinyl	■			
16oz Hi-Performance Hypalon	■			
40oz Hi-Performance Hypalon	■			

No.	DESCRIPTION
1	Adjustable head curtain – Hook and loop split
2	End cap
3	Square tube curtain support †
4	L-Pad – Side Pad
5	Wood backboard – Kiln dried †
6	2" x 4" Mounting board†
7	Flat bracket
8	4" x 24" yellow guide stripe
9	Angle bracket
10	Protective wear flaps / pleats †
11	Pulleys
12	6" Aluminum rope cleat
13	Curtain retraction cord
14	L-Pad – Face pad
15	Hook and loop for curtain
16	Weighted head curtain
17	Stays

\*Some items displayed may be optional

† Not shown on drawing

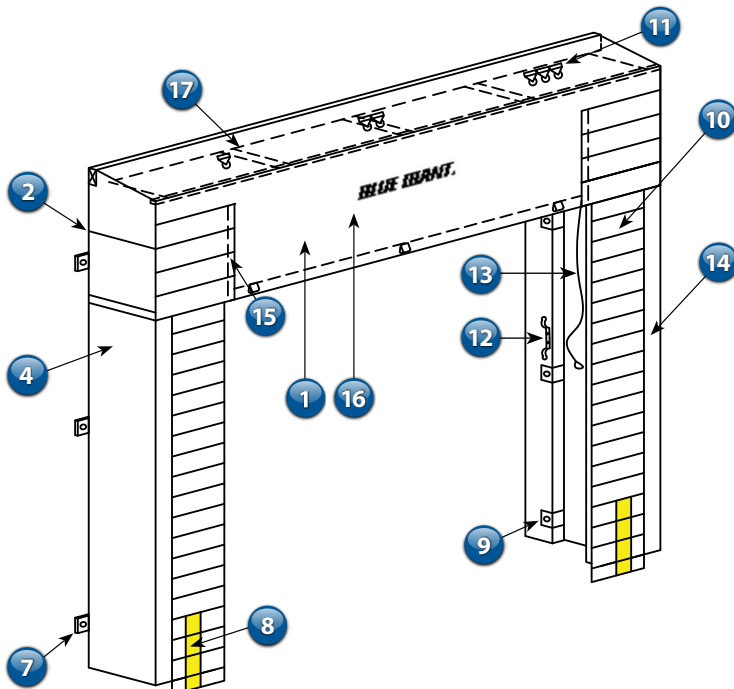

**BLUE GIANT**  
BLUE GIANT EQUIPMENT CORPORATION

Corporate 410 Admiral Blvd  
Mississauga ON L5T 2N6  
t 905.457.3900 f 905.457.2313

USA 6350 Burnt Poplar Road  
Greensboro, NC 27409  
[www.BlueGiant.com](http://www.BlueGiant.com)

SS-BGDSFA-2023

Blue Giant offers a full line of dock levelers, dock safety equipment, seals and shelters, accessories, ergonomic and scissor lift equipment and industrial trucks. Concurrent with our continuing product improvement program, specifications are subject to change without notice. Please contact Blue Giant for latest information. Some features illustrated may be optional in certain market areas.